

5021# SFST15-120 水車攻牙動力頭(牙桿傳動)(大陸專利號：7529700)
Tapping Spindle Head /Flange Type/Lead Screw Transmission
(SIPO Patent No. 7529700)

規格	Model	SFST15
攻牙能力	Tapping Capacity(S45C)	M50
最大行程	Max. Stroke	120mm
螺旋導程	Thread Guide Pitch	0.8~3.0mm
馬力	Horsepower, 3 Phase	5HP×4P
主軸皮帶輪	Spindle Pulley	8M-72T
主軸軸承	Spindle Bearing	6014Z×1, 6012Z×1 32014×1, 32012×1
皮帶輪軸承	Pulley Bearing	6214ZZ×2
前蓋油封	Front Cover Seal	TC150-180-14×1
前蓋O型環	Front Cover O-ring	G120×1 / G150×1
主軸油封	Spindle Seal	TC90-100-12×1
活塞O型環	Piston O-ring	P150×2

Roundness: $\leq 0.003\text{mm}$

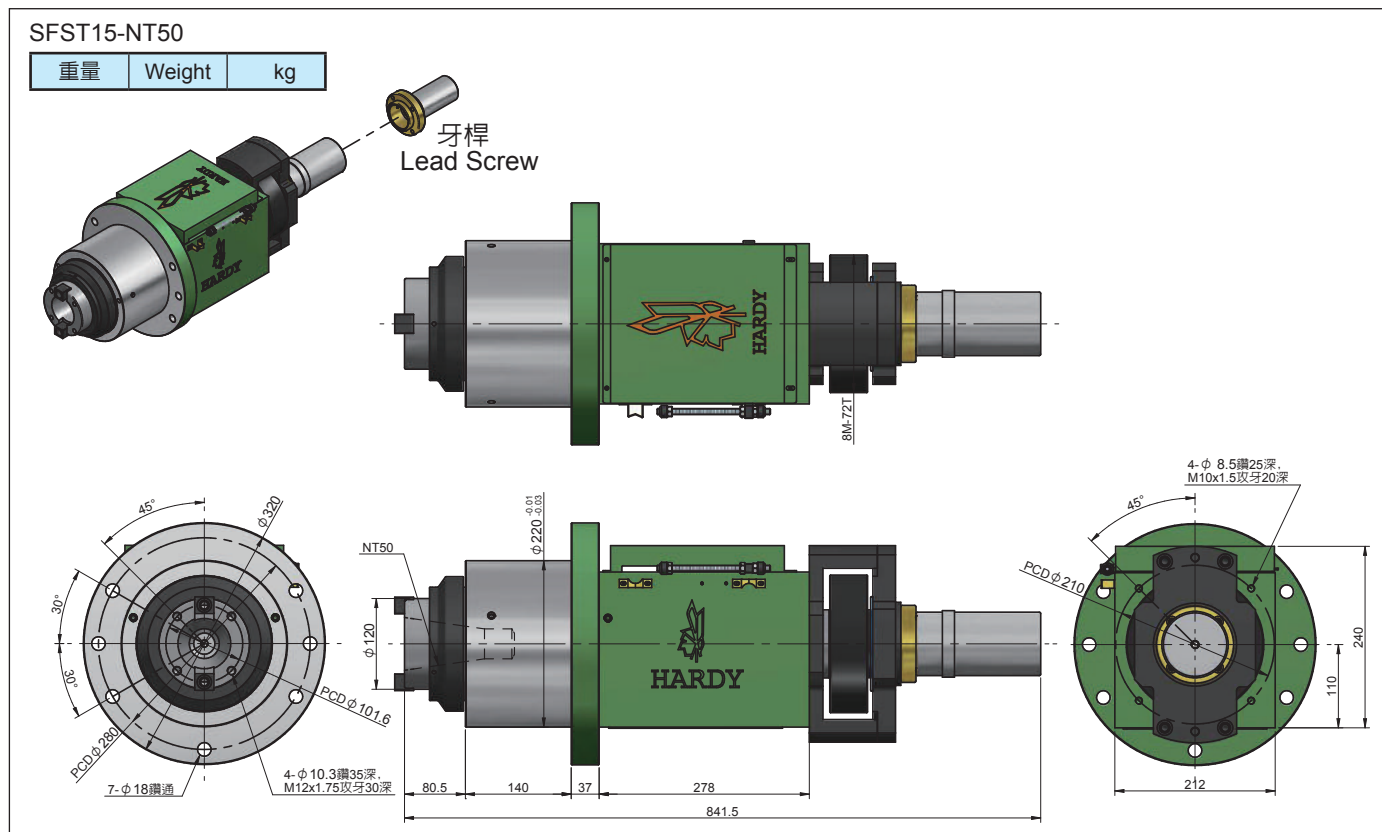

5021# SFST15-120

水車攻牙動力頭(牙桿傳動) (大陸專利號：7529700) Tapping Spindle Head /Flange Type/Lead Screw Transmission (SIPO Patent No. 7529700)

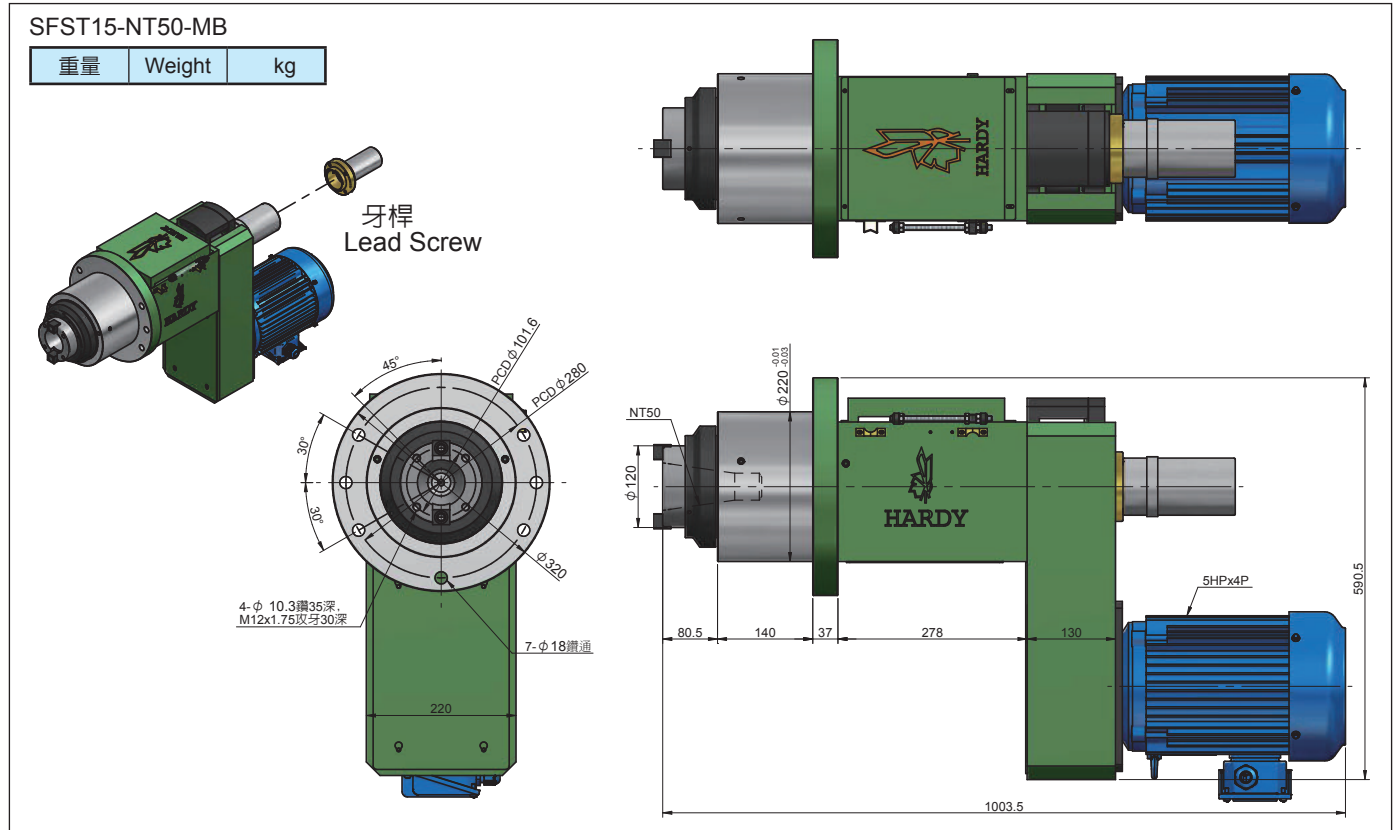

可接受特殊規格動力頭訂製
We accept Special Spindle Unit Order

